

This article was downloaded by:

On: 26 January 2011

Access details: *Access Details: Free Access*

Publisher *Taylor & Francis*

Informa Ltd Registered in England and Wales Registered Number: 1072954 Registered office: Mortimer House, 37-41 Mortimer Street, London W1T 3JH, UK



Liquid Crystals

Publication details, including instructions for authors and subscription information:

<http://www.informaworld.com/smpp/title~content=t713926090>

Tetrabenzocyclododecatetraene A new core for mesogens exhibiting columnar mesophases

H. Zimmermann^a; R. Poupko^b; Z. Luz^b; J. Billard^c

^a Max-Planck-Institut für Medizinische Forschung, AG Molekülkristalle, Heidelberg, F.R. Germany ^b

The Weizmann Institute of Science, Rehovot, Israel ^c Laboratoire de Physique de la Matière Condensée, Collège de France, Paris, France

To cite this Article Zimmermann, H. , Poupko, R. , Luz, Z. and Billard, J.(1988) 'Tetrabenzocyclododecatetraene A new core for mesogens exhibiting columnar mesophases', *Liquid Crystals*, 3: 6, 759 – 770

To link to this Article: DOI: 10.1080/02678298808086532

URL: <http://dx.doi.org/10.1080/02678298808086532>

PLEASE SCROLL DOWN FOR ARTICLE

Full terms and conditions of use: <http://www.informaworld.com/terms-and-conditions-of-access.pdf>

This article may be used for research, teaching and private study purposes. Any substantial or systematic reproduction, re-distribution, re-selling, loan or sub-licensing, systematic supply or distribution in any form to anyone is expressly forbidden.

The publisher does not give any warranty express or implied or make any representation that the contents will be complete or accurate or up to date. The accuracy of any instructions, formulae and drug doses should be independently verified with primary sources. The publisher shall not be liable for any loss, actions, claims, proceedings, demand or costs or damages whatsoever or howsoever caused arising directly or indirectly in connection with or arising out of the use of this material.

Tetrabenzocyclododecatetraene

A new core for mesogens exhibiting columnar mesophases

by H. ZIMMERMANN

Max-Planck-Institut für Medizinische Forschung, AG Molekülkristalle,
Jahnstrasse 29, D-6900 Heidelberg, F.R. Germany

R. POUPKO and Z. LUZ

The Weizmann Institute of Science, Rehovot 76100, Israel

and J. BILLARD

Laboratoire de Physique de la Matière Condensée†, Collège de France,
Paris, France

Octasubstituted derivatives of tetrabenzocyclododecatetraene are found to exhibit thermotropic mesophases. The molecules of these mesogens are highly flexible with an average four-fold symmetry. Optical and differential scanning calorimetry measurements are presented on five ester and ether derivatives. All mesophases appear to be columnar with a negative optical anisotropy. From the five compounds studied the four which are derived from aliphatic ester and ether are optically uniaxial, while the mesophase of the decylbenzoyloxy derivative could be biaxial. Miscibility measurements performed with some discotic and pyramidic mesogens of similar molecular dimensions suggest that the mesophases of the tetrabenzocyclododecatetraene core form new families of columnar mesophases.

1. Introduction

Recently several new thermotropic columnar mesophases which differ from the discotics have been discovered [1-4]. They are exhibited by derivatives of tribenzocyclononatriene, a rigid core with a trigonal pyramidic structure (II). Here we extend the scope of mesogens to yet another core, namely tetrabenzocyclododecatetraene (I).

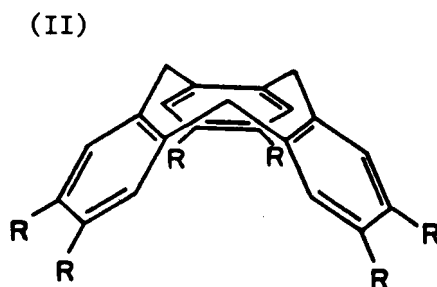
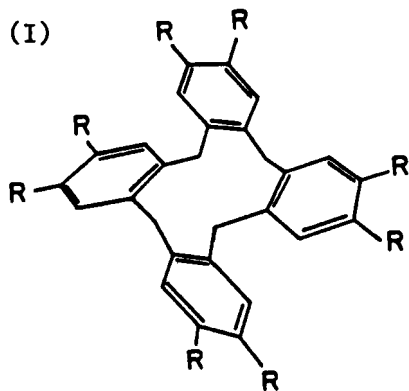

†Unité associée au CNRS No. 542.

It is a flexible moiety undergoing fast interconversion [5] between two symmetry related sofa forms to give an average four-fold molecular symmetry. The mesogens are obtained by symmetrically substituting eight side chains via ether or ester bonds. Other examples of flexible, macrocyclic molecules which exhibit columnar mesophases have recently been described by Lehn *et al.* [6].

2. Experimental

2.1. Synthesis

Acid catalyzed condensation of 3,4-dimethoxybenzylalcohol leads directly to the formation of octamethoxytetrabenzocyclododecatetraene. Cleavage of the methoxy groups by borontribromide gives the octahydroxy derivative from which the final esters or ethers are obtained by esterification or alkylation with appropriate alkanoylchloride or alkylbromide. The final compounds were purified by column chromatography, and gave satisfactory elementary analysis and N.M.R. spectra.

2.2. Differential scanning calorimetry

Transition temperatures and transition enthalpies were measured using a Mettler TA 3000 differential scanning calorimeter. The D.S.C. results are reported for increasing temperature (1 to 5°C/min).

2.3. Optical microscopy

Thin samples were observed between two untreated cover slips of ordinary glass. The textures as well as the miscibilities were studied using a polarizing microscope (Leitz, Panphot or Zeiss, Universal) equipped with a Mettler FP52 hot stage. Binary phase diagrams at atmospheric pressure were constructed by observation of contact preparations [7], and the solubilities of the solids calculated using the Le Chatelier-Schröder relation [8].

3. Results and discussion

Transition temperatures and molar enthalpy changes of the compounds studied in the present work are summarized in the table. They include two octasubstituted ethers (*n*-alkyloxy derivatives, I.1 and I.2); two esters (*n*-alkanoyloxy derivatives, I.3 and I.4) and an *n*-alkylbenzoyloxy derivative (I.5). The compounds are stable in air in the temperature ranges of the measurements, except that for long periods at high temperatures, decomposition sets in. We discuss them in turn according to their chemical classification.

3.1. The *n*-alkyloxy derivatives

Compounds I.1 and I.2 exhibit solid-solid transitions which are clearly detected by D.S.C. and by changes in the crystalline shape by microscopic observations. Slow cooling (1°C/min) of the normal liquid gives a birefringent mesophase consisting either of domains with non-uniform extinctions and irregularly curved boundaries (see plate 1), or of domains with uniform extinctions and digitized (finger-like) contours (see plate 2). Some defects with rectilinear axes, common to columnar mesophases, are also observed. When these preparations are viewed with linearly polarized light, but with the analyser removed, the rectilinear defects disappear when the electric field of the light is parallel to the defect axis. In the uniform extinction

Transition temperatures (in °C) and (in parentheses) enthalpy changes (in kJ/mole) for the octasubstituted tetrabenzocyclododecatetraene (I) derivatives studied in the present work†.

<i>m</i>	R	K_1	K_2	K_3	K_4	M	L
	$R = n-C_mH_{2m+1}-O-$						
I.1	8		6.2(2.9)	69.1(21.0)	130.0(4.2)	137.2(24.2)	153.2(15.1)
I.2	10		89.6(35.6)	111.9(33.6)			142.0(15.4)
	$R = n-C_{m-1}H_{2m-1}-C(O)O-$						
I.3	12		81.9(75.9)				246.3(27.3)
I.4	14		90.4(103.0)				237.2(25.4)
	$R = n-C_mH_{2m+1}-C_6-H_4-C(O)O-$						
I.5	10		96.4(88.0)				150.5(7.2)

† In the table K_i stands for crystalline phases, M for mesophases and L for the liquid phase.

areas two types of rectilinear axes are observed: one parallel and one making an angle of 45° with the neutral lines. In samples with non-uniform extinction areas the defect axes are oriented in different directions (see plate 1). If these preparations are viewed between crossed polarizers with an auxiliary wave plate, the quadrants of the slow neutral line appear blue and those in the perpendicular direction, red (see plate 1), hence the sign of the optical anisotropy of these mesophases is negative as is common for discotic and pyramidal mesophases. Furthermore dark areas are often observed between crossed polarizers which are not changed by rotation of the microscope stage. These areas are therefore normally oriented domains, indicating that the mesophases are optically uniaxial. From observations on defect axes with the analyser removed and shifting the focus plane up and down within the sample it can be deduced [9, 1] that the optical axes are tangent to spirals contained in planes perpendicular to the defect axis. Pressing the cover slip with a fine steel needle results in numerous defects which persist for long periods due to the high viscosity of the mesophases. When a sample of I.1 showing a uniform extinction is pressed, areas with different orientations of neutral lines appear, but for a given domain only two orientations of such neutral lines are observed making an angle of 60° with each other. The boundaries between the two types of domains are respectively rectilinear and parallel to the two directions of the neutral lines. These observations are compatible with a columnar structure for the mesophases. The uniaxiality of the mesophases ensures that they do not have a layered structure [10]. This is confirmed by the absence of Granjean's terraces in samples with a free surface. The phase diagram of I.1 and I.2 (see figure 1) shows complete miscibility of the two compounds in the mesophase region, thus establishing that they belong to the same class. The equilibrium curves exhibit a very weak minimum indicating an almost ideal solution.

3.2. The *n*-alkanoyloxy derivatives

These compounds have high clearing temperatures and therefore a high vapour pressure in the liquid state. In addition the growth rate of the mesophases from

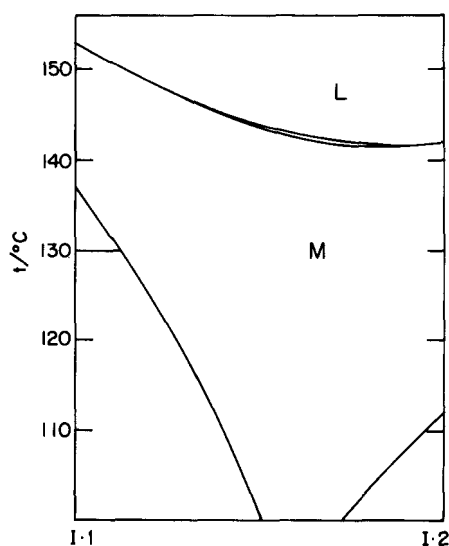

Figure 1. The phase diagram of the binary mixtures of I.1 (left) and I.2 (right).

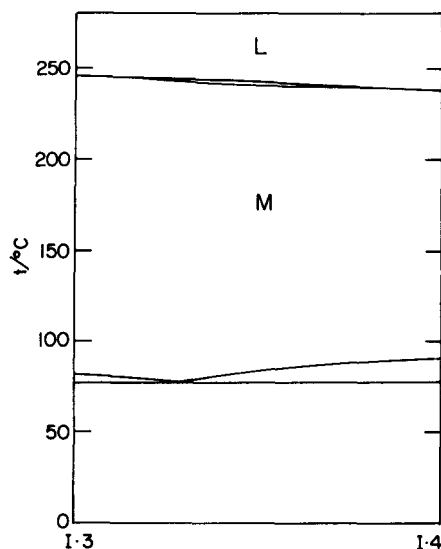

Figure 2. The phase diagram of the binary mixtures of I.3 (left) and I.4 (right).

the liquid, particularly of I.4, is extremely slow. Cooling to the mesophase gives birefringent areas with non-uniform extinctions and irregularly curved boundaries (see plate 3). Dendrite textures are often observed. After complete transformation and cooling some decorations appear (see plate 4). Observations of the type described here for compounds I.1 and I.2 indicate that the mesophases of the alkanoyloxy derivatives I.3 and I.4 also have characteristic features of columnar phases. They are uniaxial with a negative optical anisotropy, and optical axes tangent to spirals contained in the planes perpendicular to defect axes. The phase diagram of I.3 and I.4 (see figure 2) indicates that the mesophases of both compounds are of the same class.

3.3. The *n*-decylbenzoyloxy derivative

Compound I.5 with a molecular mass of 2443.5 dalton also exhibits a mesophase (see the table), although on cooling from the liquid, it shows up only after appreciable supercooling. In the presence of seeds large domains are obtained some of which can be seen to be divided in six sectors with rectilinear boundaries (see plate 5), and uniform extinctions. The walls between the sectors and the rectilinear boundaries make angles of 60° or 120°. When observed with polarized light and with the analyser removed the walls appear as dark shadows for all orientations of the microscope stage and focusing planes. We also observe single parallelogram domains with uniform extinctions, as well as areas exhibiting defects with rectilinear axes, having similar characteristics to those described above for the alkyloxy and alkanoyloxy derivatives. The optical anisotropy of the mesophase is negative; however, no normally oriented areas were detected suggesting that this mesophase could be optically biaxial.

3.4. Additional miscibility studies

To compare the mesophases M of the ethers and M' of the esters a binary phase diagram was constructed from two compounds having similar side chain lengths, I.3 and I.2 (see figure 3). The results suggest that the mesophases are different and that the mesophase M of the ethers is stable at temperatures lower than those of the M'

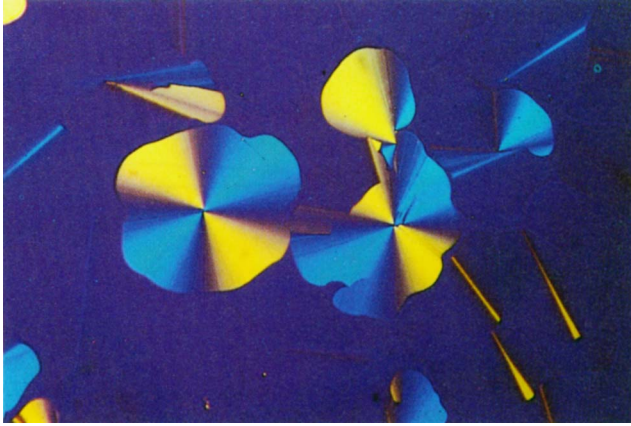

Plate 1. Mesophase of I.2 formed by slow cooling of the liquid phase. The preparation is inserted between crossed polarizers (polarization planes are along the N-S and W-E directions) with an auxiliary wave plate (slow neutral line in the SW-NE direction) ($T = 139^{\circ}\text{C}$).



Plate 2. Mesophase of I.1 with digitized contours obtained by slow cooling of the liquid phase and viewed between crossed polarizers, with a wave plate inserted ($T = 152^{\circ}\text{C}$).



Plate 3. Mesophase of I.3 obtained by slow cooling of the liquid phase and viewed between crossed polarizers ($T = 239^{\circ}\text{C}$).

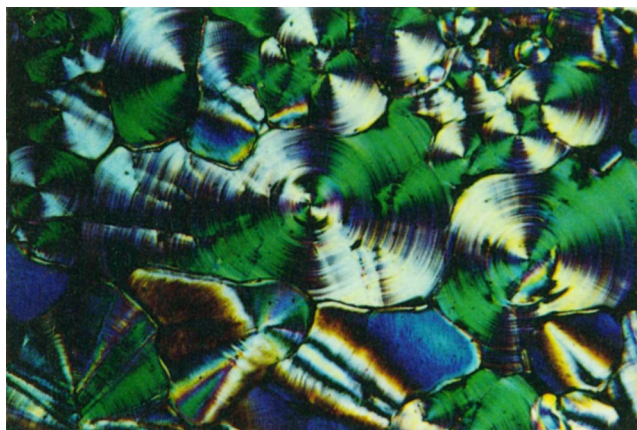

Plate 4. Mesophase of I.3 after cooling to 120°C .

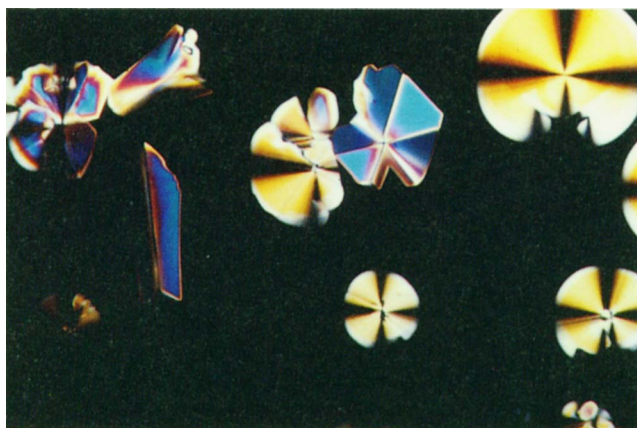

Plate 5. Mesophase of I.5 obtained by very slow cooling of the liquid phase and viewed between crossed polarizers ($T = 147^{\circ}\text{C}$).

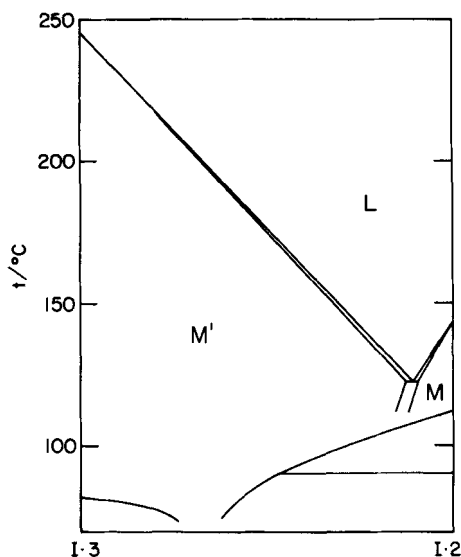

Figure 3. The phase diagram of the binary mixtures of I.3 (left) and I.2 (right).

mesophase of the esters. We were not successful in constructing phase diagrams of mixtures I.5 with either the ether or ester derivatives, because the very slow growth rate of the mesophase resulted in thermal decomposition of the sample. We hope to study these mixtures in closed cells [11].

To compare the mesophases of these tetrabenzocyclododecatetraene (I) derivatives with previously studied pyramidal mesophases of the tribenzocyclononatriene series (II) we have constructed phase diagrams for a number of binary mixtures. The phase diagram of mixtures in which the side chains of both cores I and II consist of *n*-oxyloxy groups (see figure 4) indicates that the liquid phase can be in equilibrium

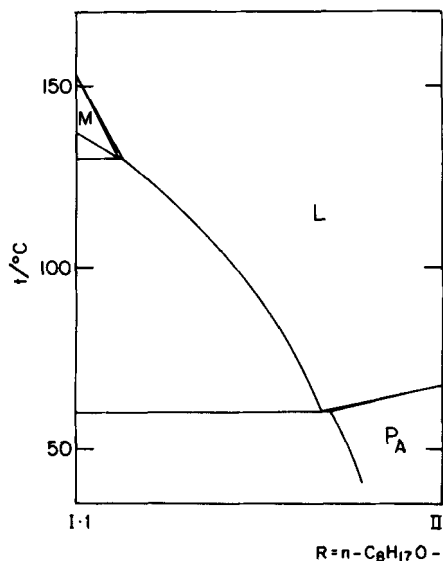

Figure 4. The phase diagram of the binary mixtures of I.1 (left) and hexa-*n*-tridecanoyloxy-tribenzocyclononatriene (right).

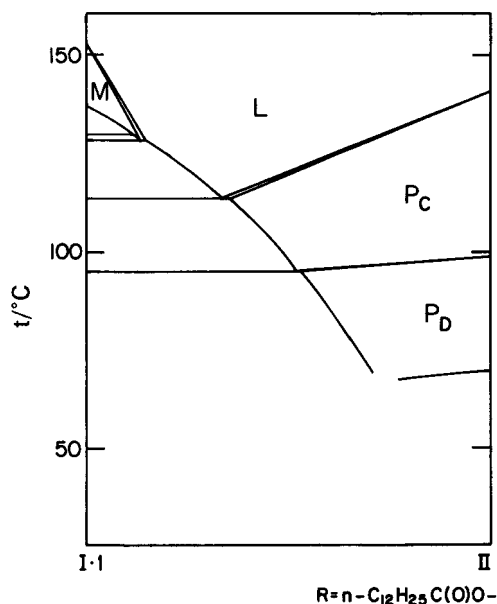

Figure 5. The phase diagram of the binary mixtures of I.1 (left) and hexa-*n*-tridecanoyloxy-tribenzocyclononatriene (right).

with crystals of the tetrabenzo compound. The general form of the diagram indicates, however, that the mesophase is probably different from the P_A mesophase of the tribenzo compound. Similarly the phase diagram of I.1 with a tribenzocyclononatriene derivative exhibiting the pyramidic P_C and P_D mesophases ($R = n\text{-C}_{12}\text{H}_{25}\text{C}(\text{O})\text{O}-$) (see figure 5) shows no equilibrium between the mesophase studied and either of the reference mesophases. Again from the general form of the diagram it appears that the mesophase of I.1 is different from the pyramidic P_C and P_D mesophases.

Since the texture of the mesophase resembles that of the discotic D_B phase we have also constructed a phase diagram of mixtures of I.1 with 1, 2, 3, 5, 6, 7 hexa-*n*-octanoyloxyanthraquinone, which exhibits D_B in a comparable temperature range [12]. The phase diagram (see figure 6) is similar to that observed in mixtures with the pyramidic mesogens, strongly suggesting that the mesophase of the alkyloxy derivatives of I are not of the discotic B type. It should be emphasized, however, that in the latter three phase diagrams no equilibrium contact boundary between the mesophases occurs, and consequently the difference of the corresponding phases is not conclusively proved.

Similar experiments were made in order to compare the optically uniaxial mesophase of I.3 and I.4 with the optically uniaxial pyramidic mesophases P_A and P_C of the tribenzocyclononatriene (II) series [1]. Derivatives of comparable side chains of both cores were used. Because of the slow growth rate of the mesophase of the tetrabenzo-alkanoyloxy derivatives the following procedure was adopted to study the contact preparation. Crystals of the tetrabenzo compound were inserted between two cover slips and heated to the mesophase region. Pressing with a fine steel needle, this paste gave a compact area. After cooling to room temperature, crystals of the tribenzo reference compound were placed near the edge of the upper cover slip, and the preparation heated again to the clearing point of the latter, which entered by capillarity to form contact with the tetrabenzo compound. Although the

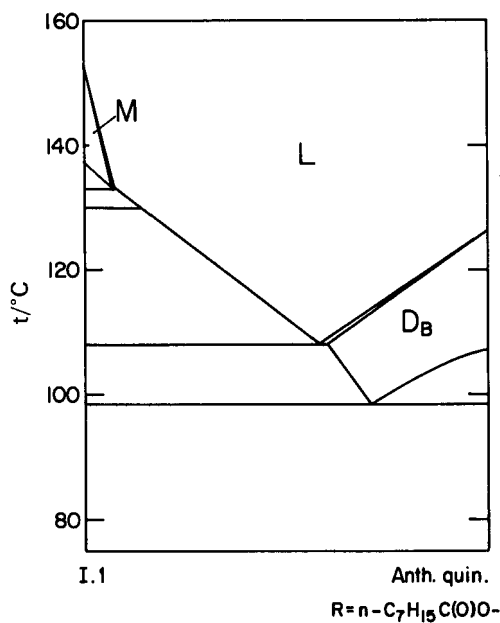

Figure 6. The phase diagram of the binary mixtures of I.1 (left) and hexa-*n*-octanoyloxy-anthraquinone (right).

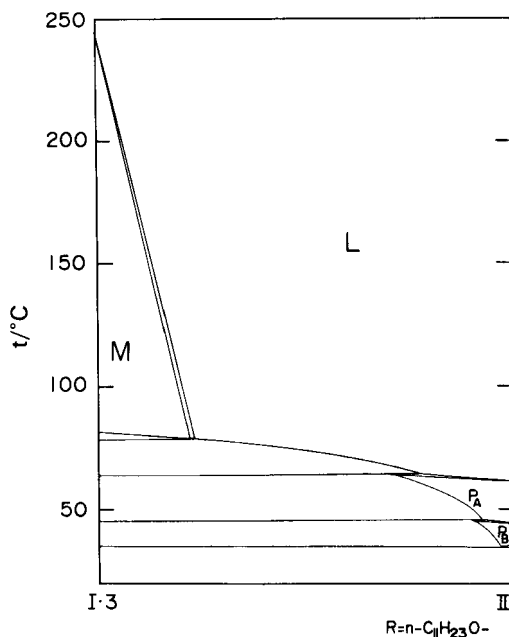

Figure 7. The phase diagram of the binary mixtures of I.3 (left) and hexa-*n*-undecyloxytri-benzocyclonatriene (right).

phase diagram so obtained (see figure 7) does not show boundary contact between the mesophases, it appears that the mesophase of I.3 is different from P_A .

Figure 8 shows the phase diagram of I.4 and the hexa-myristoyloxy derivative of II which exhibits the pyramidal P_C and P_D mesophases. Some of the phase changes are

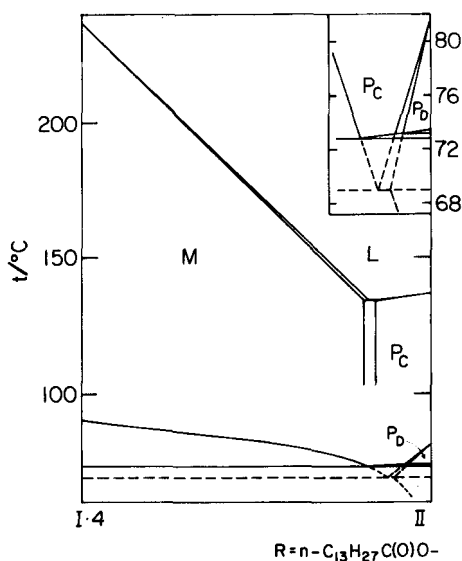

Figure 8. The phase diagram of the binary mixtures of I.4 (left) and hexa-myristoyloxytribenzocyclonatriene (right).

very slow in this system, and the transition between P_C and P_D is difficult to observe with a microscope. It is however clear that the mesophase of I.4 is different from P_C . The concentration change at the equilibrium between these two mesophases versus the temperature cannot be determined by observation of contact preparations.

For this reason we have not obtained the phase diagrams of the mixtures of I.5 with an appropriate tribenzocyclonatriene derivative.

4. Summary and conclusions

Expansion of the rigid tribenzocyclonatriene ring (II) to give the flexible tetrabenzocyclododecatetraene core (I) conserves the mesogenic character of the compound but has noticeable consequences on the nature of the mesophases formed. These changes involve suppression of the tendency for polymorphic mesomorphism, increase of the melting temperature, and (except for the *n*-decylbenzoyloxy derivatives) also a significant increase in the clearing temperatures and clearing enthalpies compared with the tribenzo compounds. This suggests higher ordering in the tetrabenzocyclododecatetraene mesophases compared with those of the tribenzo compounds. The mesophases of both series are columnar, but observations on binary mixtures suggest that those of the tetrabenzocyclododecatetraene series do not belong to the same classes as those of the pyramidic tribenzo compounds. The mesophases have negative optical anisotropies and those derived from aliphatic ethers and esters (I.1 and I.4) are optically uniaxial. For the latter derivatives (I.3 and I.4) optical observations (e.g. the angles between dendrites) suggest tetragonal symmetry. The mesophase of the decylbenzoyloxy derivative (I.5) exhibits a mosaic-like texture and is possibly optically biaxial.

The polar nature of the tribenzo pyramidic molecules suggests columnar arrangements with specific electrical properties (i.e. ferro- or antiferroelectric structures) for their mesophases. The tetrabenzocyclododecatetraene derivatives do not appear to have a polar structure (i.e. a crown conformation) but rather a sofa shape with C_{2h} symmetry. Moreover it is known [5] that in solutions these molecules undergo fast interconversion between

two symmetry related sofa conformations. The rate of this process is of the order of 10^2 to 10^3 s^{-1} for the methyl derivative at room temperature. We found similar kinetic parameters for the mesogenic dodecanoyloxy derivative ($\Delta E^\ddagger 52.3 \text{ kJ/mole}$; $\Delta S^\ddagger -30.1 \text{ J K}^{-1}$) using proton N.M.R. in chloroform solution. It is likely that similar isomerization rates apply also to tetrabenzo molecules in the mesophase region, resulting in an average planar four-fold symmetry for the molecules. Hence the arrangement of the molecules in the columns may be more reminiscent of the situation in discotics than in pyramidal mesophases.

We thank Dr. J. C. Dubois for the loan of the discogen used as reference compound. This research was supported by a grant from the National Council for Research and Development, Israel, and the KFA Jülich, F.R. Germany, and by the Israel Academy of Sciences and Humanities. One of us (J.B.) thanks the France-Israel Scientific Exchange Programme for a visiting fellowship at the Weizmann Institute of Science.

References

- [1] ZIMMERMANN, H., POUPKO, R., LUZ, Z., and BILLARD, J., 1985, *Z. Naturf. (a)*, **40**, 149.
- [2] MALTHETE, J., and COLLET, A., 1985, *Nouv. J. Chim.*, **9**, 151.
- [3] LEVELUT, A. M., MALTHETE, J., and COLLET, A., 1986, *J. Phys. Paris*, **47**, 3571.
- [4] ZIMMERMANN, H., POUPKO, R., LUZ, Z., and BILLARD, J., 1986, *Z. Naturf. (a)*, **41**, 1137.
- [5] WHITE, J. D., and GESNER, B. D., 1969, *Tetrahedron Lett.*, No. 13, 1591; 1974, *Tetrahedron*, **30**, 2273.
- [6] LEHN, J.-M., MALTHETE, J., and LEVELUT, A. M., 1985, *J. chem. Soc. chem. Commun.*, p. 1794.
- [7] KOFLER, L., and KOFLER, A., 1958, *Thermomikromethoden* (Verlag Chemie).
- [8] LE CHATELIER, H., 1885, *C. r. hebd. Séanc. Acad. Sci., Paris*, **100**, 50. SCHRÖDER, T., 1893, *Z. phys. Chem.*, **11**, 449.
- [9] BILLARD, J., DUBOIS, J. C., NGUYEN HUU TINH, and ZANN, A., 1978, *Nouv. J. Chim.*, **2**, 535.
- [10] BILLARD, J., 1984, *C. r. hebd. Séanc. Acad. Sci., Paris*, **299**, 905.
- [11] BUISINE, J. M., ZIMMERMANN, H., POUPKO, R., LUZ, Z., and BILLARD, J., 1987, *Proceedings of the Fifth European Winter Liquid Crystal Conference*, Borovets, Bulgaria.
- [12] QUEGUINER, A., ZANN, A., DUBOIS, J. C., and BILLARD, J., 1980, *Liquid Crystals*, edited by S. Chandrasekhar (Heyden), p. 35.